

THE VIPP V1

# Vipp Kitchen

## PRODUCT DESCRIPTION

Since 1939, every new Vipp product has been born from the same dream; to manufacture long-lasting tools for everyday life. Our kitchen is no different. Envisioned to be used every day for a lifetime, our kitchen is stripped of fading trends and filled with carefully considered and highly engineered details. It's straightforward. No compromise with materials, no fuss. Just function.



Designed with longevity in mind, we have constantly refined elements, but the basic design remains the same. Our intention is for the kitchen to follow the trajectory of the bin which has been made for over eighty years - it feels as fresh as when it was made for Marie's hair salon in 1939. To ensure the longevity of the V1 kitchen, Vipp provides spare parts for repairs, thereby extending its lifespan. Additionally, through continuous use throughout its entire lifecycle, the environmental footprint is minimized.



THE VIPP V1  
**Vipp Kitchen**

KEY SELLING POINTS

**ONE DESIGN, FOUR MODULES**

A Vipp kitchen is a modular concept. We think of it as building blocks. There are four types of modules; island, island with seating, wall and tall. Each module can be built with predefined units of your choice.

**FRAME AND WORKTOP**

The corners of the stainless steel worktop and powder-coated aluminium frame are rounded for a soft take on industrial materials. The solid, one-piece, stainless steel table top is 4 mm thick and floats above the kitchen cabinet to add a light expression to a heavy-weight material.

**POWDER-COATED ENDURANCE**

The fronts of the Vipp kitchen are made from powder-coated steel, which is highly durable and resistant to daily wear and tear.

**RAISED ON LEGS**

Inspired by furniture, the Vipp kitchen is raised on legs, adding extra functionality with easy access to cleaning. Set screws in stainless steel let you adapt the kitchen to uneven floors.

**WARRANTY**

As a testament to quality, we offer a 10-year warranty on the kitchen.



# THE VIPP V1

## Vipp Kitchen

### COLOURS

**BLACK** Vipp's signature black powder-coating has a slightly textured surface and offers a deep matte black kitchen.

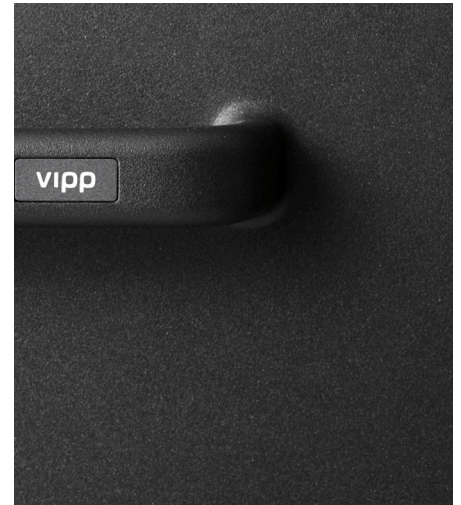

**GREY** The warm grey colour holds the same softly grained coating as the black option yet conveys a lighter design expression



**WHITE** The white option reveals a clean and polished aesthetic in stark white with a smooth, matte surface texture.



THE VIPP V1  
**Vipp Kitchen**

4 MODULES



Island module



Island w. seating module



Wall module



Tall module

THE VIPP V1  
**Vipp Kitchen**

PRODUCT DETAILS

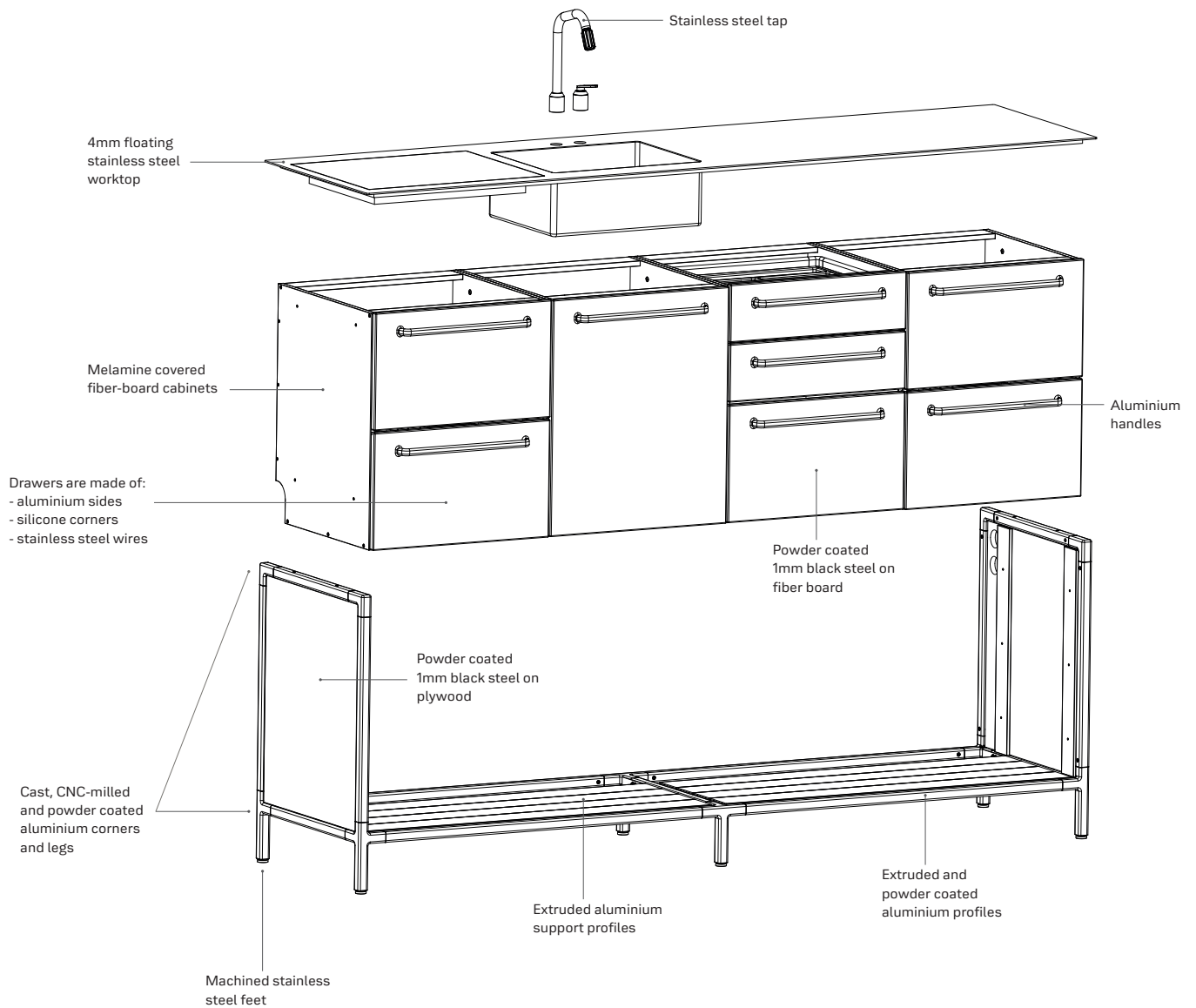

THE VIPP V1  
Vipp Kitchen

ISLAND MODULES

Compose your island module of 3-10 units on each side.

Dimensions:

H. 92 cm / 36.2 in.

D. 127 cm / 50 in.

W. 187-607 cm / 73.6-239 in.

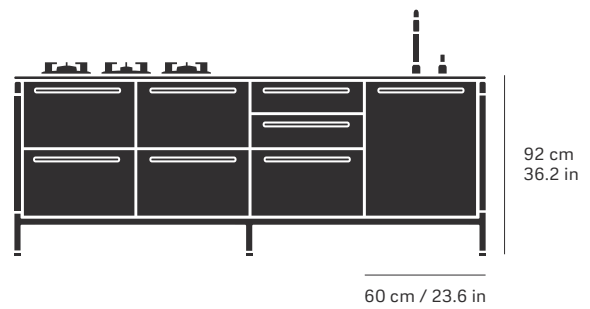
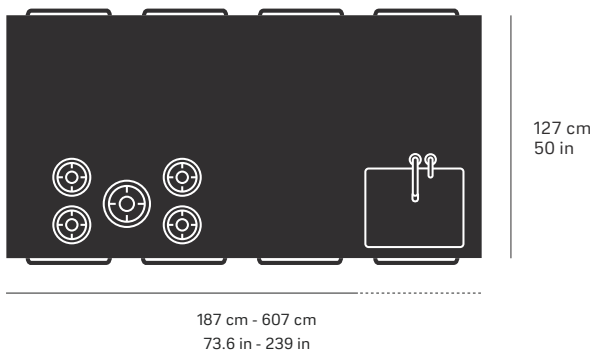

SELECTION OF UNITS

Dimensions unit:

H. 92 cm / 36.2 in.

D. 63.5 cm / 25 in.

W. 60 cm / 23.6 in.



Sink  
Cabinet



Large sink  
Four drawers w.  
waste sorting\*

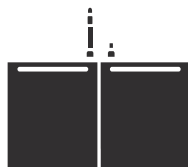

Large sink  
Two doors



Oven  
/steam oven



Microwave  
Warming drawer



Steam oven  
Warming drawer



Dishwasher  
w. drawer



3 gas hobs  
Two drawers



5 gas hobs  
Four drawers



Induction  
Two drawers



Large Induction  
Downdraft &  
two cabinets\*



Large induction  
Four drawers



Cabinet  
w. one fixed shelf



Two drawers



Two drawers  
w. waste sorting



Three drawers



Three drawers  
w. waste sorting



Wine cooler

Additional units may be available in your region. \* Not available in US

THE VIPP V1  
Vipp Kitchen

ISLAND MODULES W. SEATING

Compose your island module w. seating of 3-10 units on each side.

Dimensions:

H. 92 cm / 36.2 in.

D. 95 cm / 37.4 in.

W. 127-607 cm / 50-239 in.

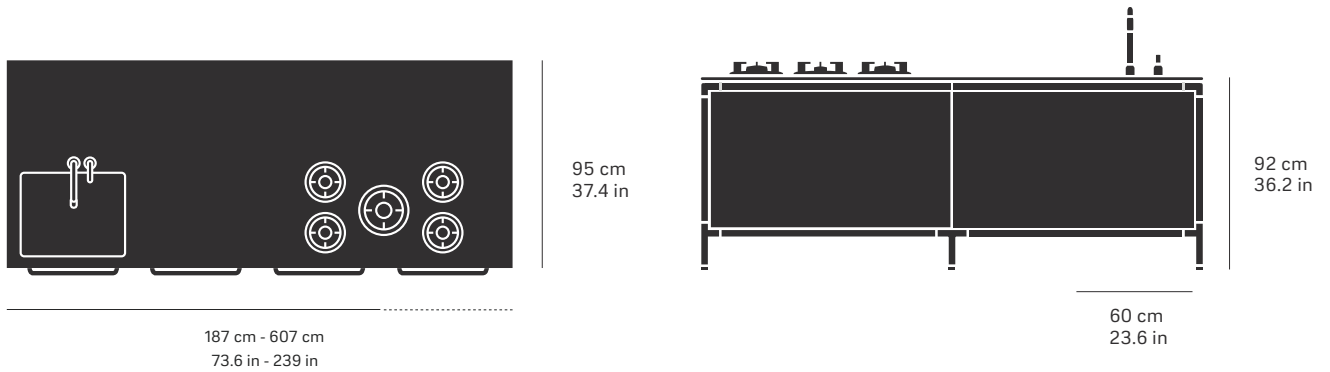

SELECTION OF UNITS

Dimensions unit:

H. 92 cm / 36.2 in.

D. 95 cm / 37.4 in.

W. 60 cm / 23.6 in.



Sink  
Cabinet

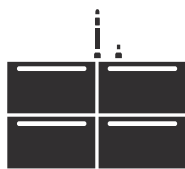

Large sink  
Four drawers w.  
waste sorting\*

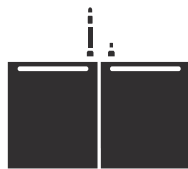

Large sink  
Two doors



Oven  
/steam oven



Microwave  
Warming drawer



Steam oven  
Warming drawer



Dishwasher  
w. drawer



3 gas hobs  
Two drawers



5 gas hobs  
Four drawers



Induction  
Two drawers



Large Induction  
Downdraft &  
two cabinets\*



Large induction  
Four drawers



Cabinet  
w. one fixed shelf



Two drawers



Two drawers  
w. waste sorting



Three drawers



Three drawers  
w. waste sorting



Wine cooler

Additional units may be available in your region. \* Not available in US

THE VIPP V1  
Vipp Kitchen

WALL MODULE

Compose your wall module of 1-10 units.

Dimensions:

H. 92 cm / 36.2 in.

D. 65 cm / 25.6 in.

W. 67-607 cm / 26.4-239 in.

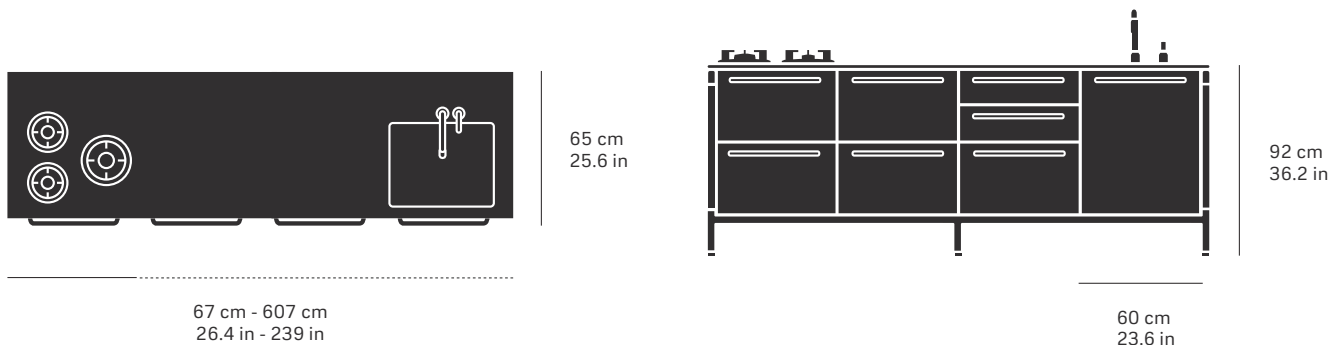

SELECTION OF UNITS

Dimensions unit:

H. 92 cm / 36.2 in.

D. 65 cm / 25.6 in.

W. 60 cm / 23.6 in.



Sink  
Cabinet



Large sink  
Four drawers w.  
waste sorting\*

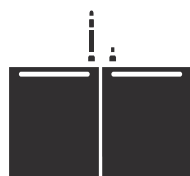

Large sink  
Two doors



Oven  
/steam oven



Microwave  
Warming drawer



Steam oven  
Warming drawer



Dishwasher  
w. drawer



3 gas hobs  
Two drawers



5 gas hobs  
Four drawers



Induction  
Two drawers

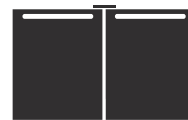

Large Induction  
Downdraft &  
two cabinets\*



Large induction  
Four drawers



Cabinet  
w. one fixed shelf



Two drawers



Two drawers  
w. waste sorting



Three drawers



Three drawers  
w. waste sorting



Wine cooler

Additional units may be available in your region. \* Not available in US



THE VIPP V1  
**Vipp Kitchen**

TALL MODULE

Compose your tall module of 1-10 units.

Dimensions:

H. 200 cm / 78.7 in.

D. 65 cm / 25.6 in.

W. 67-607 cm / 26.4-239 in.

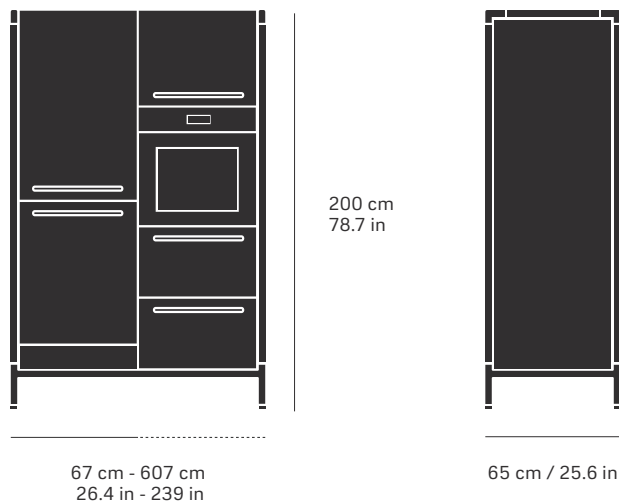

SELECTION OF UNITS

Dimensions unit:

H. 200 cm / 78.7 in.

D. 65 cm / 25.6 in.

W. 60 cm / 23.6 in.

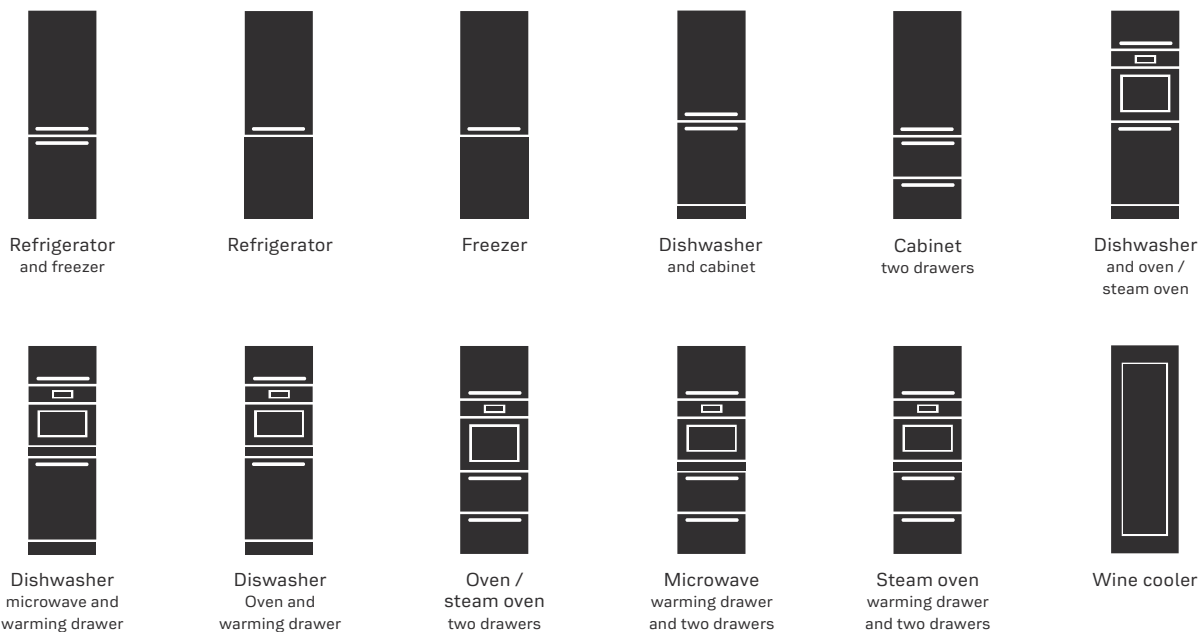

Additional units may be available in your region. \* Not available in US

## THE VIPP V1 Vipp Kitchen

### VIPP475-476 RACK TALL & EXTENSION

Vipp rack is a modular shelving system made in powder-coated steel and aluminium with black laminated shelf tops. Choose a stand-alone rack and add matching extension units for endless modularity. With a height that corresponds to the tall Vipp kitchen modules, the tall rack adds a light expression to kitchen storage.

Dimensions:

VIPP475 Rack

H. 200 cm / 78.8 in.

D. 45 cm / 17.7 in.

W. 120 cm / 47.2 in.

VIPP922 VIPP475 Rack

H. 200 cm / 78.8 in.

D. 45 cm / 17.7 in.

W. 117 cm / 46.1 in.

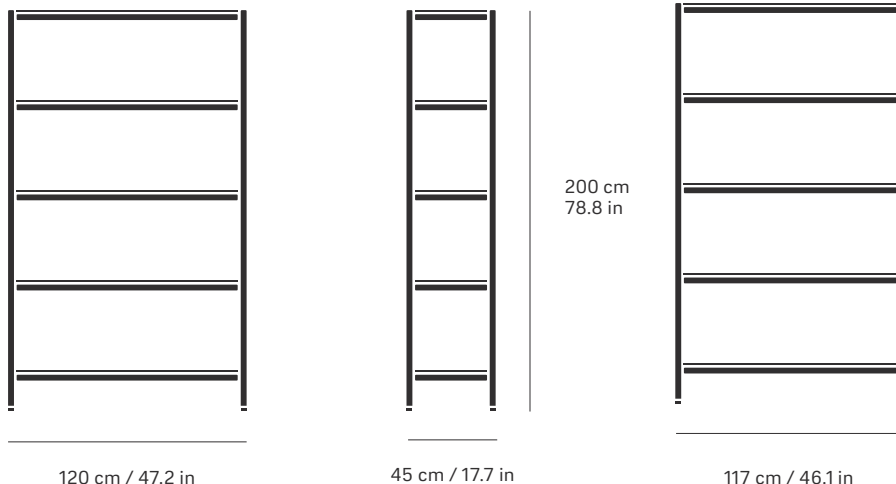

### VIPP921-922 SHELVES

Vipp shelves, U-shaped aluminium shelves that offers two levels of storage for the ready-to-grab items. Available in two sizes a small and a large.

Dimensions:

VIPP921 Shelf small

H. 23.9 cm / 9 in.

D. 19 cm / 7.4 in.

W. 100 cm / 39.4 in.

VIPP922 Shelf large

H. 23.9 cm / 9 in.

D. 19 cm / 7.4 in.

W. 50.5 cm / 19.9 in.



# THE VIPP V1

## Vipp Kitchen

### FEATURES

**FRAME AND WORKTOP** The corners of the stainless steel work-top and powder-coated aluminium frame are rounded for a soft take on industrial materials. The solid, one-piece, stainless steel table top is 4 mm thick and floats above the kitchen cabinet to add a light expression to a heavy-weight material.

**HANDLES** Mounted on front profiles pressed from the surface, the bespoke handles feature a soft interior silicone profile; a design detail securing a firm grasp.

**SINK AND KITCHEN TAP** For an uninterrupted expression the stainless steel table top features an integrated sink available in two sizes with Vipp kitchen tap in stainless steel.

**PULL-OUT NOZZLE** The Vipp tap is designed with a pull-out nozzle for an easy sink clean-up. Grooves in the stainless steel are both a functional means for a firm grip when hands are wet while also being an aesthetic design detail.

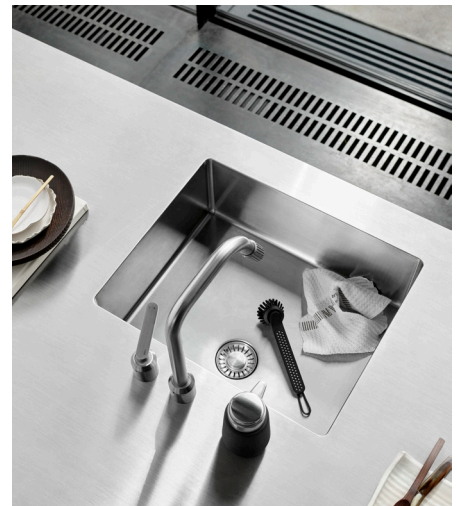

# THE VIPP V1

## Vipp Kitchen

### FEATURES

**DRAWERS** Careful detailing adds extra function to the drawers of the Vipp kitchen. The sides of all drawers are fitted with silicone profiles to protect delicate items.

**SECTION INSERT** Larger drawers are fitted with a non-slip removable mat. In the unit with two large drawers, one features a cross to create four smaller storage sections.



**CUTLERY INSERT** The first shallow drawer is fitted with a soft silicone insert of seven compartments to neatly organize cutlery.



**UTENSILS AND KNIFE INSERT** The second shallow drawer is fitted with an insert tailored to kitchen utensils including knives.

**CANISTERS & INSERT** A storage solution for dry foods comes in the form of an insert with sixteen holes tailored to fit the two-sized Vipp canisters. The canisters are made in 1.5 mm glass, and the canisters are fitted with a transparent rubber ring for a proper seal to give the contents a long shelf life. The canisters come in two sizes, 0.9 ml or 1.7 ml and can be bought individually.



# THE VIPP V1

## Vipp Kitchen

### FEATURES

**CABINET SHELVES** Steel-covered shelves in the cabinets echo the industrial design expression of the V1 kitchen.

**CAREFULLY CONSIDERED DETAILS** Store away your dishwashing brush under the sink until next use. The inside of the kitchen cabinet door features a rack, a hook, and a tray for excess water.



**SORT YOUR TRASH** Integrating a sustainable waste assortment solution in the Vipp kitchen, a deep drawer with five removable custom-made compartments makes sorting your trash an easy task.

**BROOM AND DUST** A removable back plate below the sink hides the plumbing and is mounted with a Vipp broom and dustpan set.



**STORAGE OPTIONS** Opt for either two cabinets or four large drawers underneath the large induction. Featured here is the cabinet solution with steel-covered shelves.

**ISLAND W. SEATING** Opting for an island w. seating gives you 30 cm / 11.8 in of legroom. The powder-coated frame extends under the bar where a steel plate covers the kitchen cabinet. The counter stool is also Vipp.



# THE VIPP V1 Vipp Kitchen

## FEATURES

**WINE COOLER** Add an extra function to your tall module with an integrated wine cooling unit.

**OVEN** Touch-to-open, rendering the handle obsolete for a streamlined aesthetic.



**INDUCTION** Opt for a flush mounted induction solution smoothly integrated into the steel worktop - with or without downdraft ventilation.

**GAS** Choose between three or five gas hobs floating seamlessly on the worktop next to gas knobs designed by Vipp.



**POWER OUTLET** The integrated power outlets add flexibility when cooking in the kitchen. The power outlet is available in a broad variety of international versions.

**VIPP17 PEDAL BIN** A bestseller for the kitchen, the largest of the of the five-sized pedal bin holds 30 litres / 8 gal of rubbish and comes with customised bin liners.

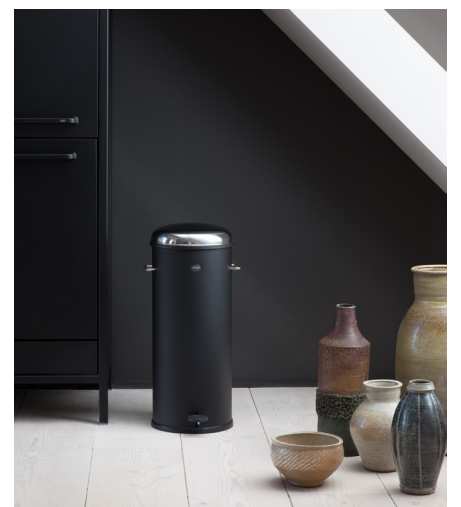

---

PRODUCT CHARACTERISTICS  
& MAINTENANCE

**CHARACTERISTICS**

The V1 kitchen is manufactured from materials shared with the Vipp bins, namely stainless steel, powder-coated aluminum and steel surfaces, and silicone.

While the Vipp kitchen is mainly made from stainless steel, some components are crafted from aluminum to optimize functionality. The drawers, made of powder-coated aluminum, ensure they are not too heavy when carrying kitchen tools and utensils.

The kitchen frames are made of aluminum, and all fronts are made of powder-coated steel. Additionally, both handles and the sides of the drawers are crafted from extruded aluminum, while the cabinets consist of 16mm melamine covered fiber-board.

Powder-coating ensures a high degree of durability.

**MAINTENANCE**

**STAINLESS STEEL WORKTOP**

Keep stainless steel clean and dry. Stainless steel may be permanently stained if water, fat or cleaning products are not removed relatively quickly. Use warm water with a mild detergent and a soft sponge or lint-free cleaning cloth for daily or regular cleaning. We recommend using the Vipp oil can for care and protection of steel surfaces.

**POWDER COATED SURFACES**

Keep powder-coated surfaces clean and dry. Use a lint-free cleaning cloth or a soft brush with warm water and a mild detergent. This applies to both smooth and rough surfaces.

**SILICONE**

We recommend cleaning the silicone mats in the washing machine at a maximum of 95°C. Make sure to thoroughly dry off the mats before placing them back in the drawers.

---

PRODUCT CERTIFICATIONS

All cabinets are E1 classified which means that the production is handled very strict and careful in terms of formaldehyde that is often used together with melamine. This classification also means that not only is the product health proofed for the client but also for workers that handles the production in our factory.

---

TEST

The kitchen has undergone rigorous testing across various parameters. This includes assessing the longevity of drawers and fronts, conducting moisture and strength tests. Our commitment to quality ensures that every aspect of our products is thoroughly scrutinized, providing assurance for the customers that their kitchen will last.

---

AVAILABILITY

Worldwide (2024)